

Panasonic

Operating Instruction

Colour Television

TX-25S90PX

Please read the operating instructions completely before operating this set.

TQB4G0540

Dear Panasonic Customer

Welcome to the Panasonic family of Customers.

We hope that you will have many years of enjoyment from your new colour television set. To obtain maximum benefit from your set, please read these Instructions before making any adjustments and retain them for future reference. Retain your purchase receipt also, and note down the serial number of your set in the space provided on the rear cover of these instructions.

Tables of Contents

Warning and Cautions 4

Before Operating This Set 6

Connect the aerial cable to the RF IN terminal

Connect the plug to the wall outlet

How to turn on the power

How to connect the " AV1 or AV2 " Input Terminals

How to connect the AV Monitor Output Terminals to the other equipment

Connecting Headphones

Location of controls 10

Remote Control Transmitter 11

How to Select the Language Function 12

Tuning Procedure 13

Automatic search

Manual search

Fine tuning

How to cancel the Fine Tuning

Programme Number Skip

How to cancel the Skip Function

General Operation 19

How to switch the power on or off

Programme number selection

Direct programme number selection

Two digit programme number selection

Volume adjustment

TV/AV selection

Sound Mute

Game

Recall

Off timer

Normal

Function

Colour system

Sound system

Advanced Remote Control Operation 25

Surround sound operation

Picture Menu operation

Sound Menu Operation

Fastext

Teletext Operation 29

Sub Coded Page Access 30



Operation of the VCR 31

Troubleshooting 32

specification 33

Warnings and Cautions

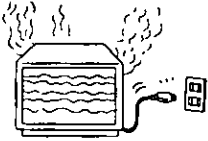
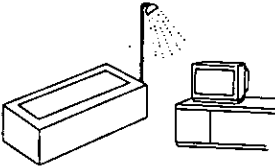

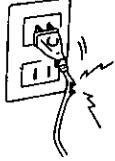
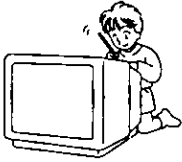
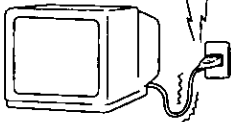
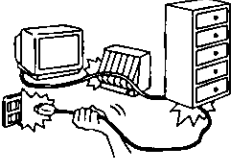
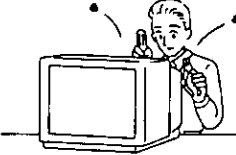
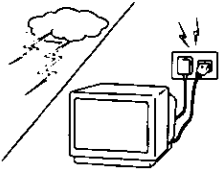
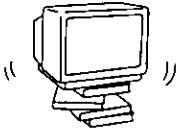



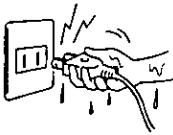

⚠ Warnings

| | | | |
|-------------------------------------------------------------------------------------|-------------------------------------------------------------------------------------------------------------------------------------------------------------------------------------------------------------------------------------------------------------------------------------|-------------------------------------------------------------------------------------|------------------------------------------------------------------------------------------------------------------------------|
|  | <p>Unplug the power cord in the event of any malfunction (screen goes blank, no sound, odd sounds, smoke or unusual odors coming from the unit). Unplug the power cord if foreign matter or water falls into the unit, or if the unit is dropped or the cabinet is damaged.</p> |  | <p>DO NOT use this unit near water. (near a bath tub, etc.)</p> |
|  | <p>DO NOT place any of the following on the unit: Flower vases, flower pots, cups, small metal objects, or cosmetics containers, chemicals or water.</p> |  | <p>DO NOT use if the power cord or power plug is damaged, or if the plug does not fit tightly into the socket.</p> |
|  | <p>DO NOT insert foreign objects (metal or easily flammable objects).</p> |  | <p>DO NOT use at a voltage other than indicated.</p> |
|  | <p>TAKE CARE NOT to damage the power cord.</p> |  | <p>DO NOT remove the rear cover as live parts and High Voltage components are accessible when the rear cover is removed.</p> |
|  | <p>DO NOT touch the aerial cable and this unit when there is lightning.</p> |  | <p>DO NOT place in an unstable location.</p> |

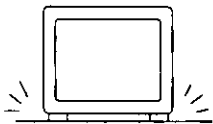
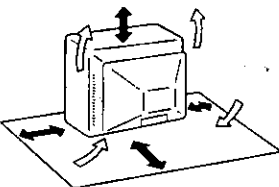

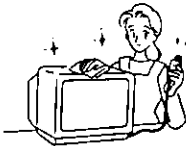
⚠ Cautions

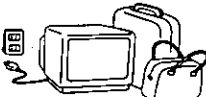
| | | | |
|-------------------------------------------------------------------------------------|---------------------------------------------------------------------------------------------------------------------------------------------------------------|-------------------------------------------------------------------------------------|-----------------------------------------------------------|
|  | <p>DO NOT place in humid or dusty locations, or areas exposed to smoke or steam. DO NOT place under direct sunlight and other sources of direct heat.</p> |  | <p>DO NOT touch the power-plug if your hands are wet.</p> |
|-------------------------------------------------------------------------------------|---------------------------------------------------------------------------------------------------------------------------------------------------------------|-------------------------------------------------------------------------------------|-----------------------------------------------------------|

Warnings and Cautions

|  Cautions | | | |
|---------------------------------------------------------------------------------------------------|-----------------------------------------------------------------------------------------------------------------------------------------------------------------------------------------------------------------------------|------------------------------------------------------------------------------------|---------------------------------------------------------------------------|
|  | <p>DO NOT stand, or place heavy objects on the unit. Particular care should be taken by families with small children.</p> |  | <p>Place in a safe location.</p> |
|  | <p>Adequate ventilation is essential to prevent failure of electrical components, we recommend that a gap of at least 10cm (↔) is left all around this unit even when it is placed inside a cabinet or between shelves.</p> |  | <p>Turn the power "Off" before connecting other electrical equipment.</p> |
|  | <p>Before cleaning, unplug the power plug from the socket.</p> |  | <p>DO NOT jolt the unit.</p> |
|  | <p>Unplug the power plug from the socket if you are not going to use the unit for an extended period.</p> |  | <p>Ask your sales outlet to install the aerial.</p> |

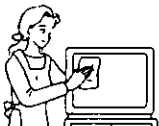
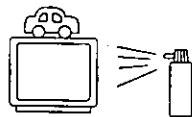
Cleaning

| | | | |
|-------------------------------------------------------------------------------------|--------------------------------------------------------------------------------------------------------------------------------------------------------------------------------|-------------------------------------------------------------------------------------|------------------------------------------------------------------------------------------------------------------------------------------------------------------------------------------------------------------------------------------------------------------------------------------------------|
|  | <p>The unit contains many plastic parts. For this reason DO NOT use benzene, thinner or other chemicals to clean the unit.</p> |  | <p>Dust will accumulate on the picture screen. Please wipe with a soft cloth from time to time. If you use a chemically treated cloth, please be careful to follow the instructions that come with the cloth.</p> |
|  | <p>DO NOT bring into contact with insecticide or other volatile substances. DO NOT allow the unit to come into contact for extended periods with rubber or vinyl products.</p> |  | <p>Remove dirt and soiling by wiping with a light cloth. Even if the unit is heavily soiled, do not apply cleaner directly to the unit. Soak a cloth in a solution of neutral cleanser thinned with water. Then wring out the cloth, wipe the unit clean, and finish by wiping with a dry cloth.</p> |

Before Operating This Set

Connect the Aerial Cable to the RF In Terminal

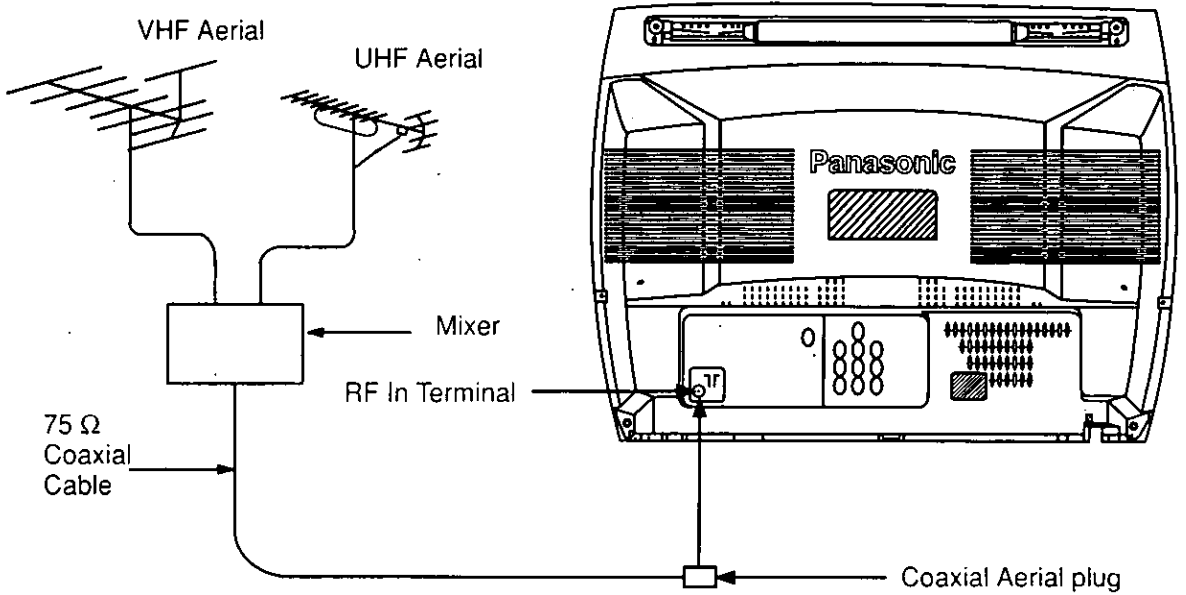

To obtain the best quality picture and sound, an external antenna, the correct cables (75 Ohm coaxial) and the correct terminating plug will be required.

If a communal antenna system is used, you may require the correct connection cable and plugs between the wall antenna socket and your television receiver.

Your local Television Service Dealer may be able to assist you in obtaining the correct antenna system for your particular area and accessories required.

Any matters about antenna installation, upgrading of existing systems or accessories required, and the cost incurred, are the responsibility of the customer.

Note :

If your existing antenna system uses 300 Ohm to 75 Ohm Balun, see Below.

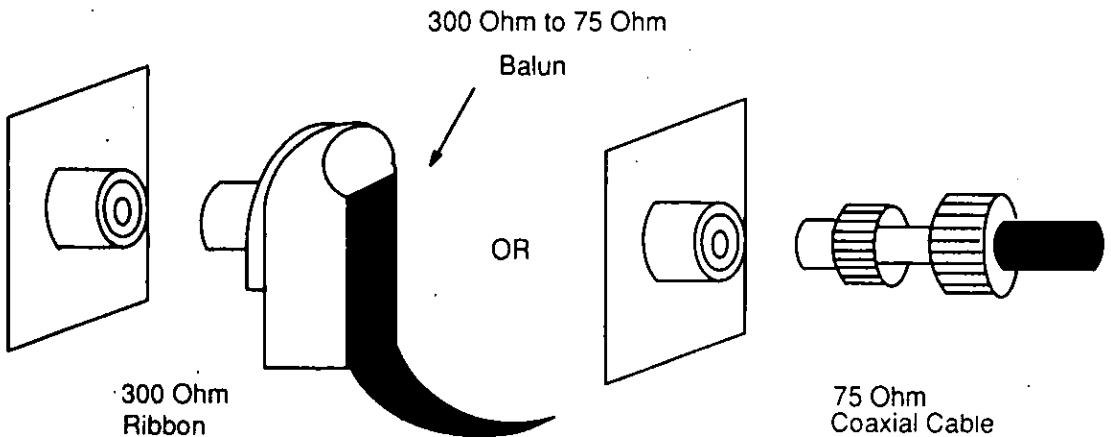

Before Operating This Set

Connect the Plug to the Wall Outlet

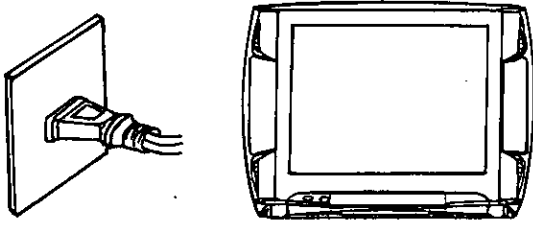

NOTE :

Mains plug type vary between countries. The mains plug shown at left may therefore not be the type fitted to your set.

How to turn on the power

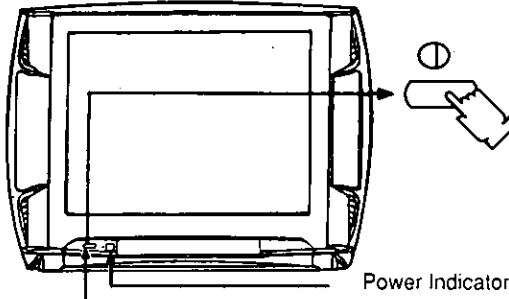

Main Power Switch

Power Indicator

Push the Main Power switch on the Television to turn the set on. The Power Indicator will light. (Red)

NOTE :

1) When in the stand – by condition (Refer to page 19), it is possible to turn the TV set on by pushing the " Power (Stand – by) " button or the Channel Up and Down button on the TV set or Remote Control.

Battery installation

1

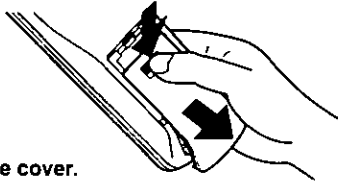

Open the cover.

Apply slight downward pressure while pulling towards the bottom.

2

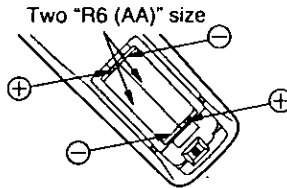

Batteries : Use two " R6 (AA) " size batteries.

Insert the batteries ensuring correct polarity. This is identifiable by the "+" and "-" symbols on both the batteries and inside the battery compartment.

3

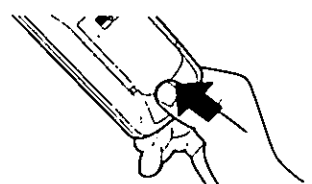

Replace the cover.

Battery Precautions

Incorrect use of batteries can cause electrolyte leakage which will corrode the remote control transmitter or cause the batteries to burst.

The following precautions must be carefully observed.

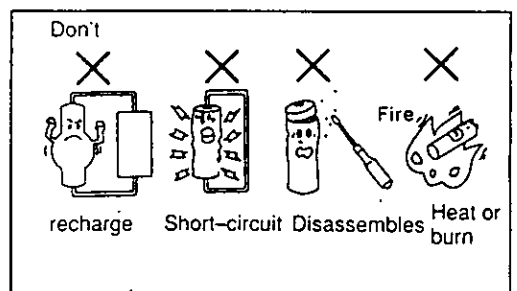
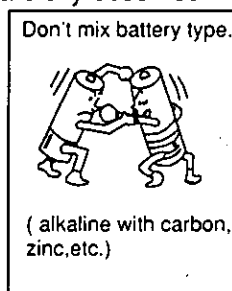
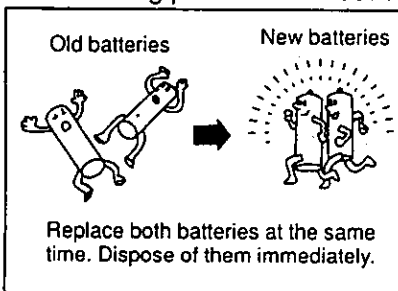

Connections

How to connect the " AV1 or AV2 " Input Terminals.

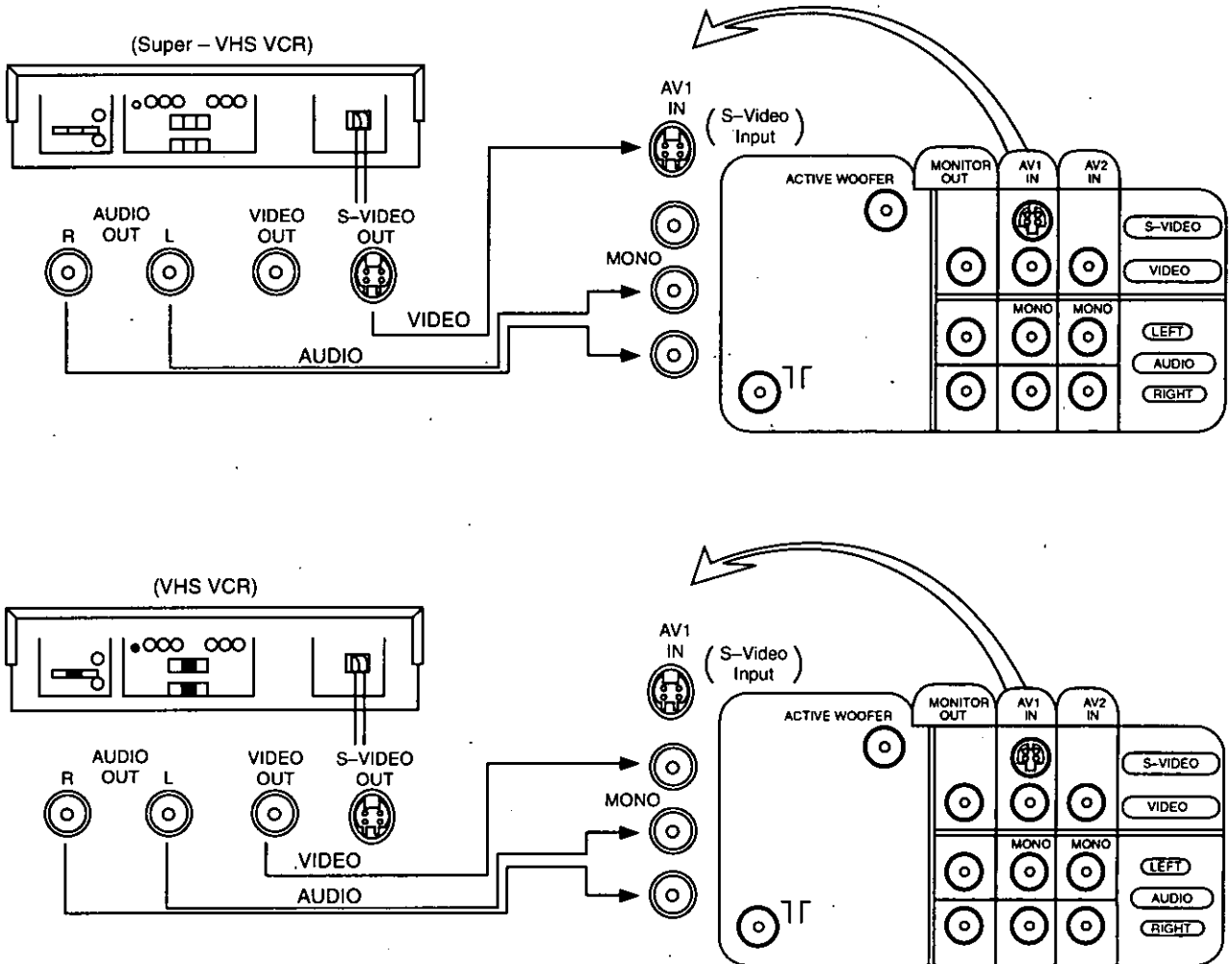

Note :

1. When AV1 or AV2 is selected, and that AV mode has no input picture signal, the Background Colour of the TV screen will change. (This only occurs if the Recall function is set to the OFF condition; refer to page 21 for details).
2. When the S-Video cable is connected to the S-Video terminal, the Phono Video input will be automatically switched off for that AV mode.
3. When a Monaural VCR is used, connect the Monaural Audio cable to the Audio "L" (Left) terminal.
4. Similar connections are available at the AV1 and AV2 input terminals.
Select the desired AV input position by pressing the TV/AV button (Refer to page 20).

Connections

How to connect the AV MONITOR OUTPUT terminals to the other equipment.

The monitor out terminal output the same signals as are on the TV screen at that time.
e. g. TV programmes or signals from AV1 or AV2 input.

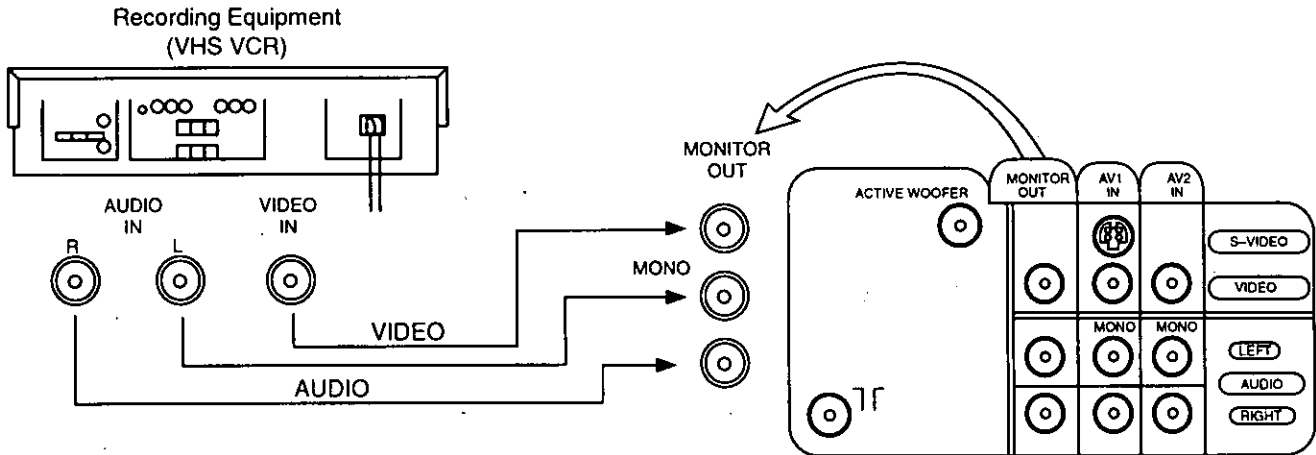

Note:

- (1) Never connect the same video recorder with both the VIDEO IN and MONITOR OUT terminals on this TV set, as this could cause incorrect operation.
- (2) Teletext display on the screen will not be output at the MONITOR OUT terminal.

Connections

Connecting Headphones

Connect headphones as follows.

When a headphones plug is inserted into the Headphones socket all speakers will be automatically disconnected; only the Headphones will function.

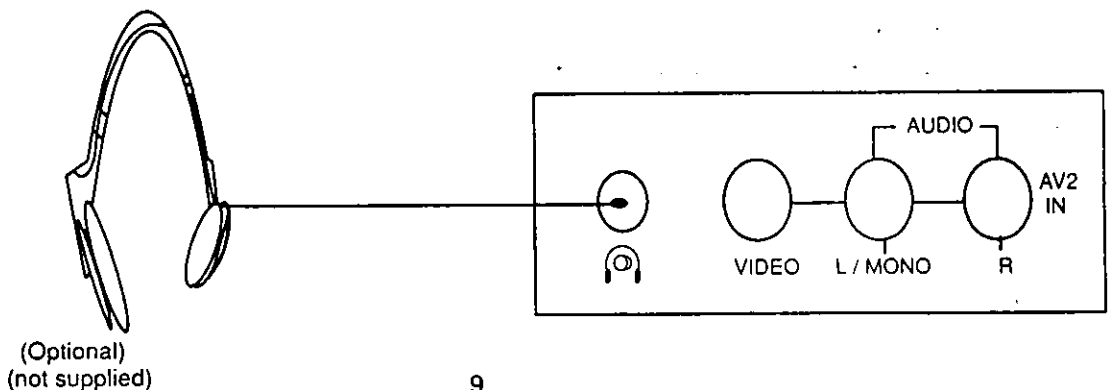

Location of Control (TV)

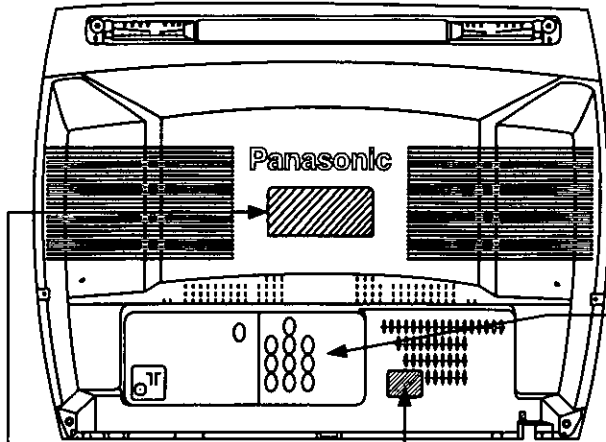
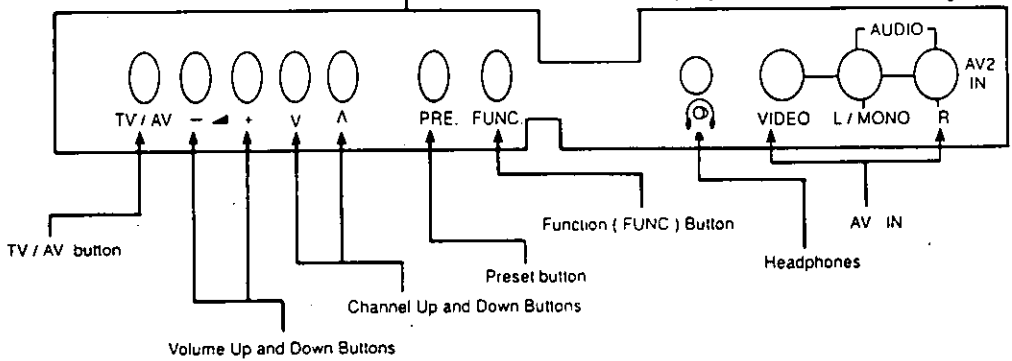
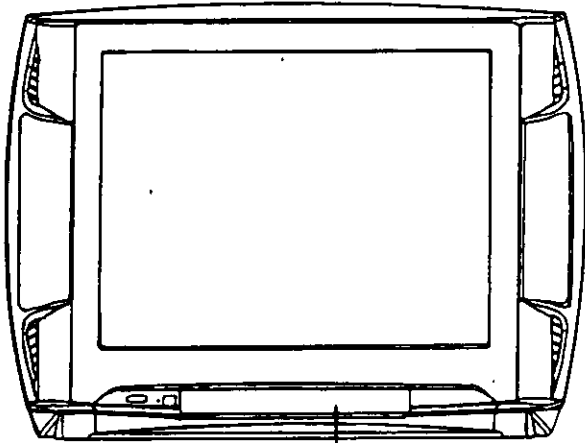

Model Name Plate

Serial Number

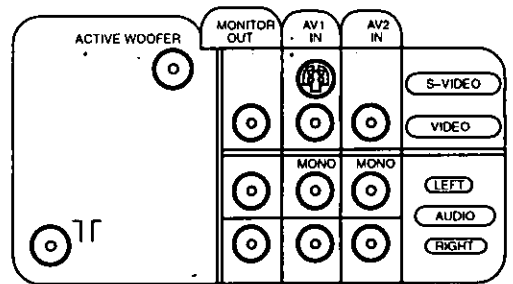

Remote Control Transmitter

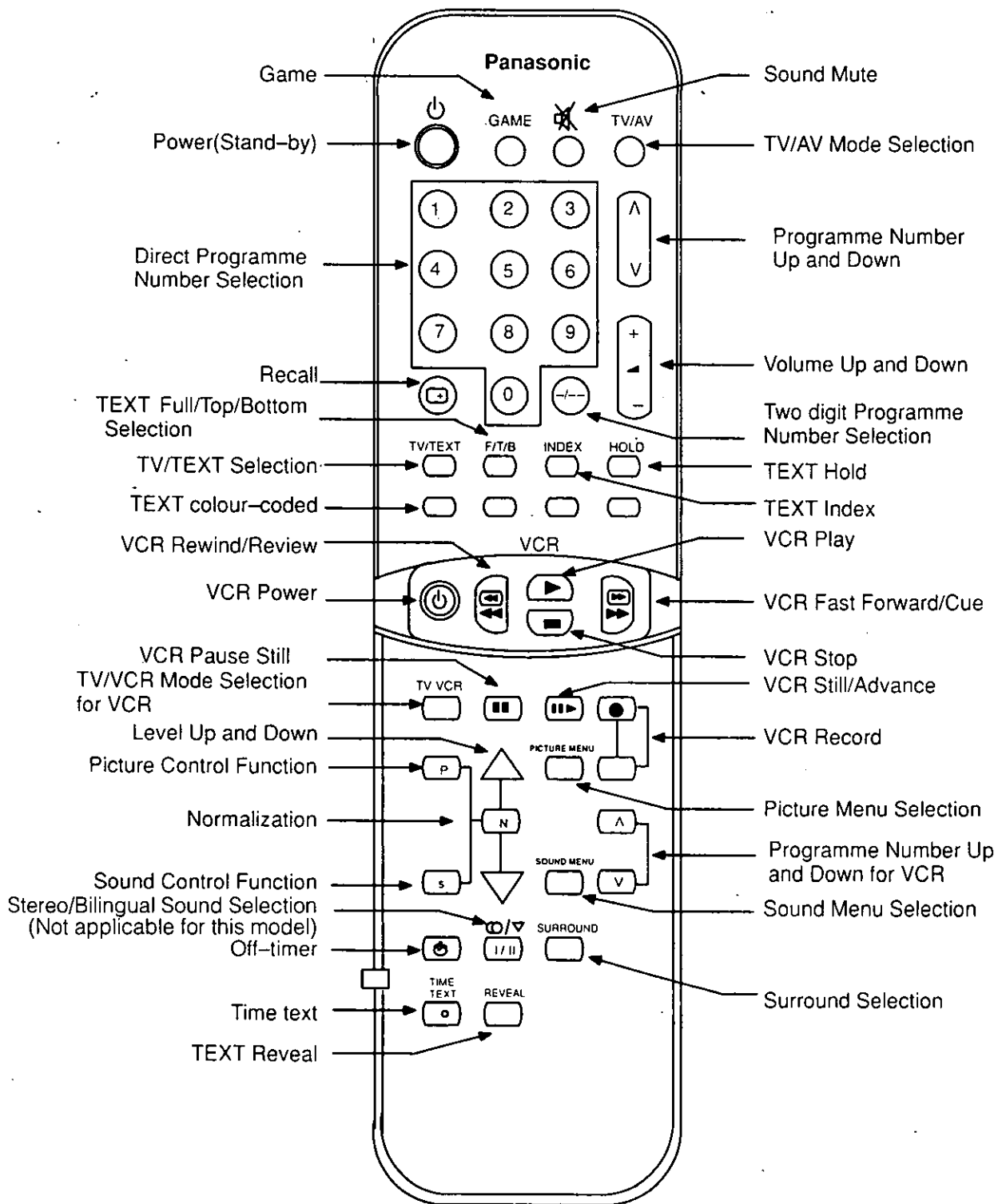

How to Select The Language Function

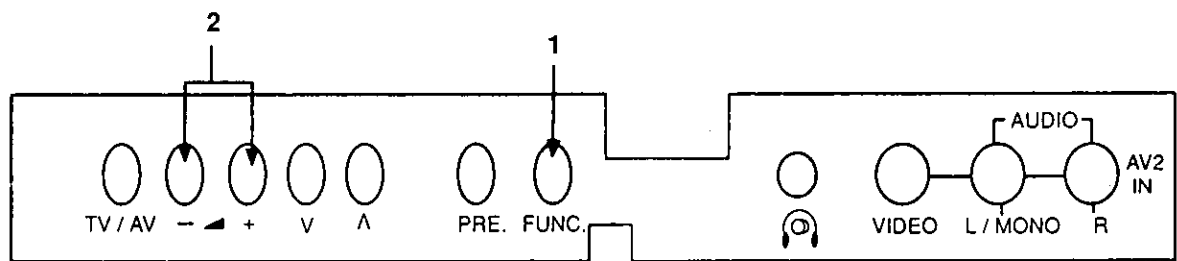

Language display on-screen can be selected by following method.

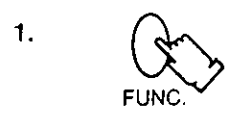

By pushing the " FUNC. (Function) button, you can select the LANGUAGE Selection Mode.

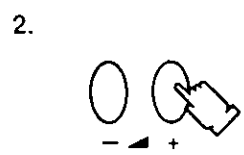
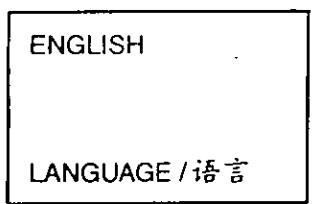

Push the Volume Up " + " button . The on screen language display will change.

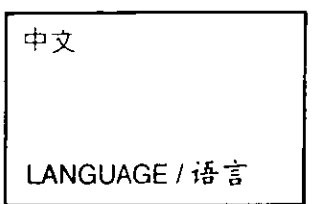

3.

This return the set to the normal viewing condition after 10 seconds.

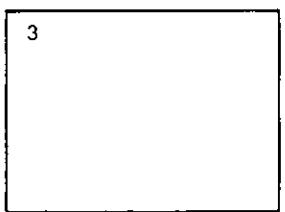

Tuning Procedure

Automatic Search

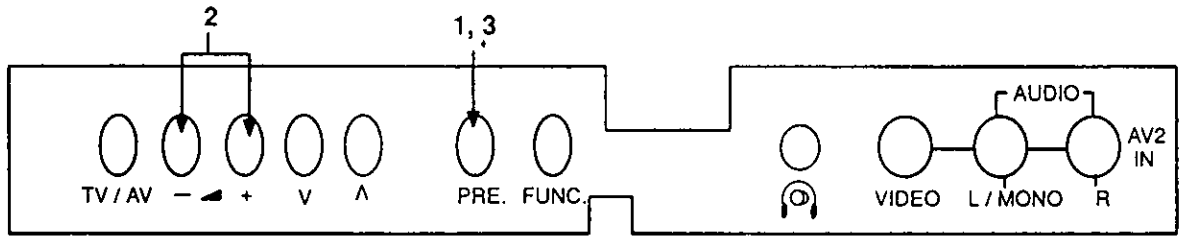

1.  Press the "PRE." (PRESET) button, setting the Automatic search mode.

1 AUTO SRCH VL
5.5MHz AUTO

Channel Number .
Automatic search condition.

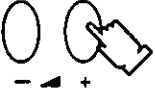
2.  Press the Volume Up "+" button.

0 AUTO SRCH VL
-|-----

Search start.

The best tuning position is automatically memorized.



0 AUTO SRCH VL
5.5MHz AUTO

3.  Press the "PRE." (PRESET) button 3 times.

0

This returns the set to the normal viewing condition.

Helpful Hints

1. If a clear picture with correct colours cannot be obtained when a broadcast or AV signal is received, refer to the "Colour System Selection" operation on page 23.
2. When the sound is not clear or no sound is produced on a programme number, refer to the "Sound System Selection" operation on page 24.
3. Repeated pressing of the "PRE." (PRESET) button changes the Preset Menu as follows:

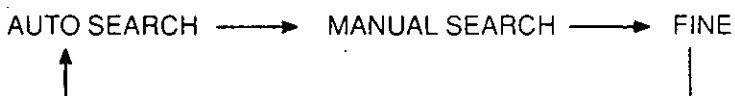

Tuning Procedure

Manual Search

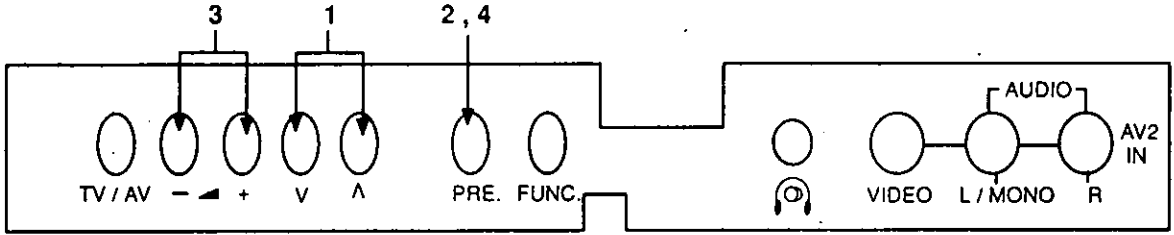

1.  Press either the Channel Up or Down button.

2

Select the desired Channel Number.

2.  Press the " PRE " (PRESET) Button twice, setting the manual Search Mode.

2 MNL SRCH VL
5.5MHz AUTO

Manual Search Condition.

3.  Press the Volume Up " + " or Down " - " button .
Volume " + " : Next higher Channel
Volume " - " : Next lower Channel

2 MNL SRCH VL

Search start.

↓

2 MNL SRCH VL
5.5MHz AUTO

The best tuning position is automatically memorized.

4.  Press the "PRE." (PRESET) button 2 times.

2

This returns the set to the normal viewing condition.

Helpful Hints

1. If a clear picture cannot be obtained even when a Broadcast is received, refer to the " Colour System Selection " operation on page 23
2. When the sound is not clear or no sound is produced on a Channel Number, refer to the "Sound System Selection" operation on page 24.
3. In case of NTSC M System, select the Sound System to 4.5 MHz. (Refer to page 24)

Tuning Procedure

Fine Tuning

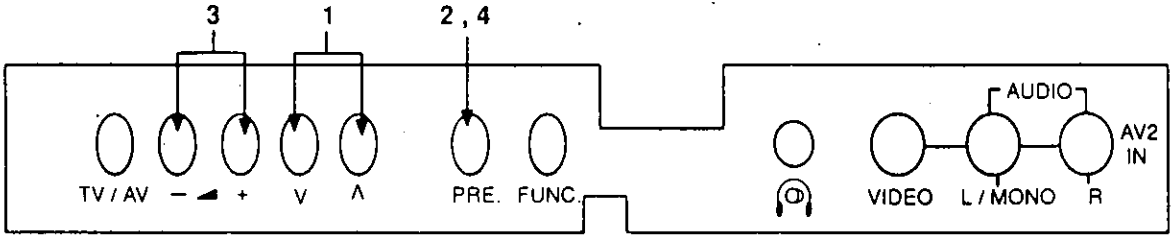

Under normal reception condition, this function is not used. However, in areas of poor reception or constant interference, a slight adjustment on the fine tuning can improve the picture and sound quality.

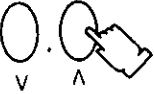
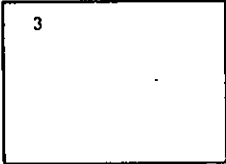
1.  Select the channel which you want to try to improve, using the Channel Up or Down buttons.  Select the desired Channel Number.

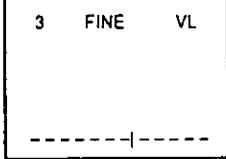
2.  Press the "PRE." (PRESET) button 3 times, setting the Fine Tuning Mode.  Fine Tuning Condition.

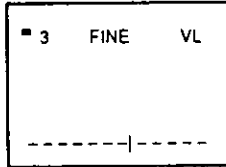
3.  Press the Volume Up "+" or Down "-" button until the picture is received.  The AFC (Automatic Frequency Control) function is deactivated. The "■" symbol appears to the left of the Channel Number.

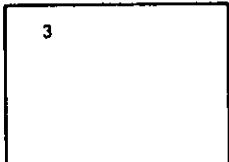
4.  Press the "PRE." (PRESET) button.  This returns the set to the normal viewing condition.

Tuning Procedure

How to Cancel the Fine Tuning

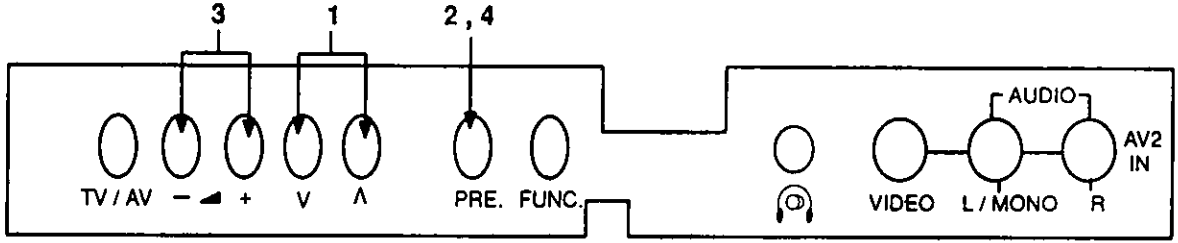

Cancelling previously adjusted (manually) fine tuning, means re – activating the AFC (Automatic Frequency Control) Function, also known as AFT (Automatic Fine Tuning). Re – activating the Automatic Fine Tuning means alamping the set to automatically tune to the optimum tuning position, for that Channel Number.

1.  Select the " AFC OFF " Channel Number which you want to return to Automatic Frequency Control (Cancel the manual fine tuning).

= 7

" AFC OFF " Channel Numbers are indicated to you by the "=" symbol to the left of the Channel Number.

2.  Press the " PRE. " (PRESET) button twice, setting the Manual Search Mode.

= 7 MNL SRCH VH
5.5MHz AUTO

Manual Search Condition.

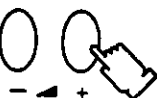
3.  Press the Volume Up "+" or Down "-" button briefly.

7 MNL SRCH VH
-----+-----

The best tuning position is automatically memorized.

4.  Press the "PRE." (PRESET) button twice.

7

This returns the set to the normal viewing condition.

Tuning Procedure

Programme Number Skip

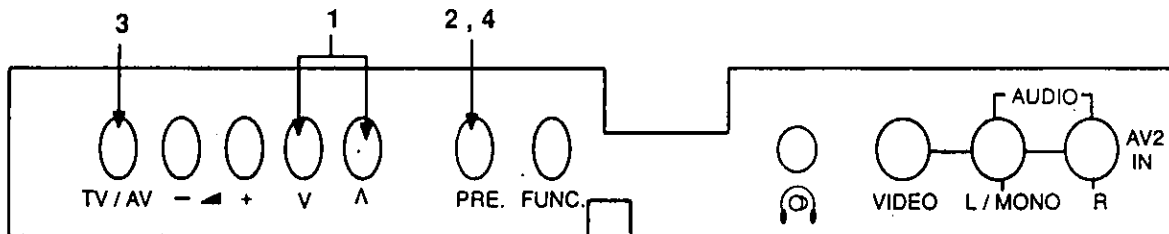

It is possible to Skip Programme Numbers on which no TV stations are tuned appearing on the screen.

The function is only effective when selecting Programme Numbers by pushing the Programme Number Up or Down Buttons either on the TV set or the remote Control.

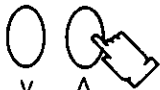
1.  Select a Programme Number you want to skip, by pushing the Programme Number Up or Down Buttons.

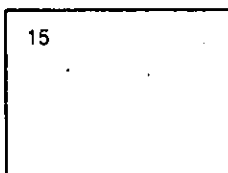

2.  Press the "PRE." (PRESET) button, setting the Automatic Search Mode.

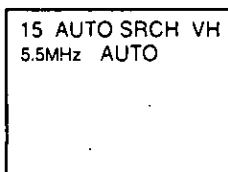

Automatic Search Condition.

3.  Press the "TV / AV selection" Button.

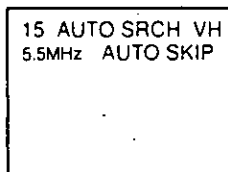

The Skip function is now set.

4.  Press the "PRE." (PRESET) button 3 times.

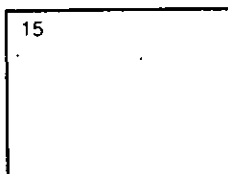

This returns the set to the normal viewing condition.

Tuning Procedure

How to Cancel the Skip Function

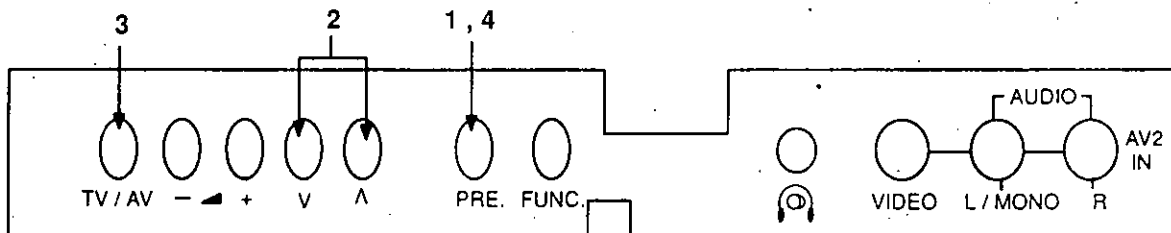

1.  Press the "PRE." (PRESET) button, setting the Automatic Search Mode.

15 AUTO SRCH VH
5.5MHz AUTO

Automatic Search condition.

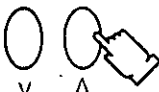
2.  Select the skipped Programme Number, by pressing the Programme Number Up "Λ" or Down "V" buttons.

10 AUTO SRCH VH
5.5MHz AUTO SKIP

The "SKIP" indicator will appear on the screen.

3.  Press the "TV/AV" selection button.

10 AUTO SRCH VH
5.5MHz AUTO

Repeat step 2 and 3, if you wish to cancel the Skip function on any other programme Number.

The skip function is now cancelled.

4.  Press the "PRE." (PRESET) button three times.

10

This returns the set to the normal viewing condition.

General Operation

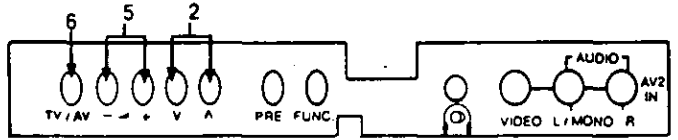
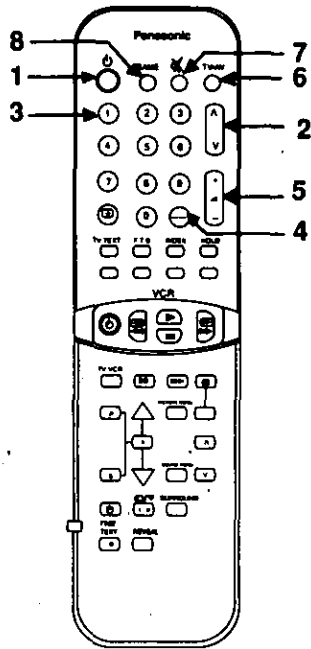

1.



To Switch Power on/off

The TV set must be switched on at the wall outlet and at the Main power switch.
 Press this button to turn the TV set ON, from stand-by mode.
 Press it again to turn off.

2.

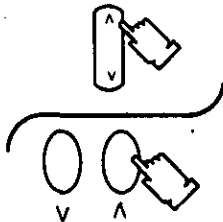

Programme Number Selection

Press the programme number Up "V" or Down "A" button to select the next higher or lower programme number.

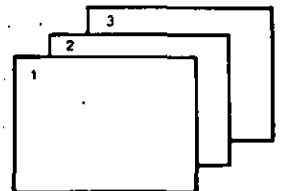

3.



Direct Programme Number Selection

(0 - 9)

e. g. To select programme number "1", press the "1" button.

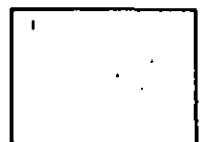

General Operation

Two Digit Programme Number Selection

4. e.g. To select Programme Number "24".

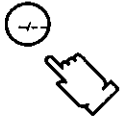

Push the button.

Push the button.

Push the button.

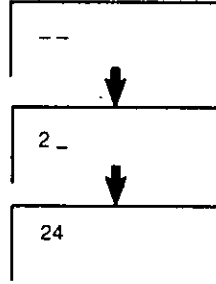

You can select a two Digit Programme Number.

| | |
|---------------|--------|
| Setting range | 0 ~ 99 |
|---------------|--------|

5. **Volume Adjustment**

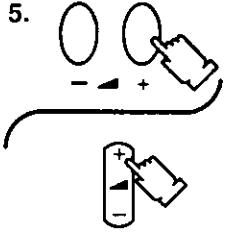

Push the Volume Up or Down button to increase or decrease the sound volume level.

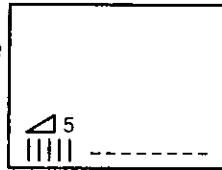

Note :

The on - screen display will indicate both numerically and graphically the volume level. Numeric levels start at " 0 " for zero or no sound, and will increase up to 63 which is the maximum sound level.

6. **TV / AV Selection**

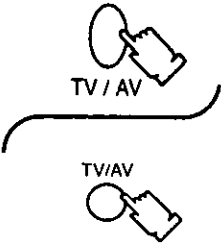

Push the " TV/AV " button to select TV, AV1, AV2 input signal modes sequentially.

Note :

If a clear picture cannot be obtained even when a AV signal is received, refer to the " Colour. System Selection " operation on page 23..

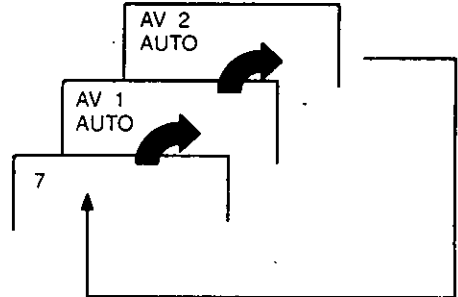

7. **Sound Mute Button**



Push this button to mute the Sound completely.

Push the button once again to restore the previous sound level, and cancel the mute.

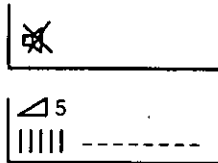

The " Mute " symbol will appear. (Colour change to Red)

8. **Game Button**



This button provides a convenient switching feature. Push this button to enter game mode (Game mode is actually AV 2 mode). To cancel the game, Push this button again.



The " GAME " Indicator will appear.

General Operation

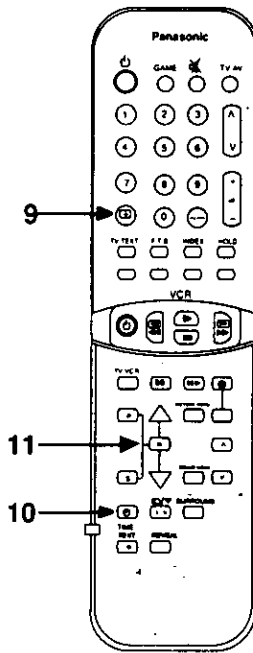

9.



Recall Button

Press the RECALL button to display the current system status. Press this button until display is cancelled.

Note:

In the AV mode, a blue colour screen appears, if there is no AV signal, when the recall function is off.

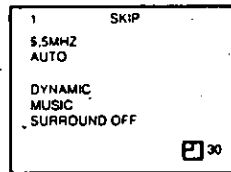

10.



Off Timer Button

The TV set may be preset to switch to stand-by after a fixed period. By pressing "Off-Timer" button, you can select the preset time either 30, 60, or 90 minutes.

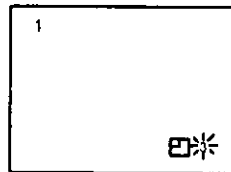
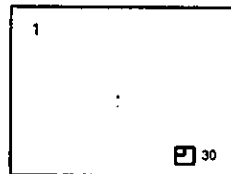
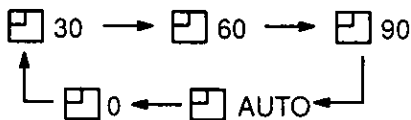

When the off-timer reaches its last 3 minutes, it starts blinking before going to stand-by condition.

Note:

Setting Off-timer to AUTO mode.

If the set is not switched off, when the TV station ends broadcasting, it will automatically go to the stand-by condition after 5 minutes. This AUTO mode will not operate when the TV receiver is in AV mode.

How to cancel the OFF-timer setting:

1. Set the preset time condition to "0" mode by pressing the Off - timer button.
2. Turning the TV set off.

11.



Normal (N) Button

By pushing the Normal " N " Button on the Remote Control while the Picture or Sound Control Function is displayed, the Selected function will be changed to the Normal Mode.

Normalization will not occur if the function is not displayed when the " N " button is pushed.

The Normal mode is the factory preset condition. Returning to this original condition is called " Normalization "

General Operation

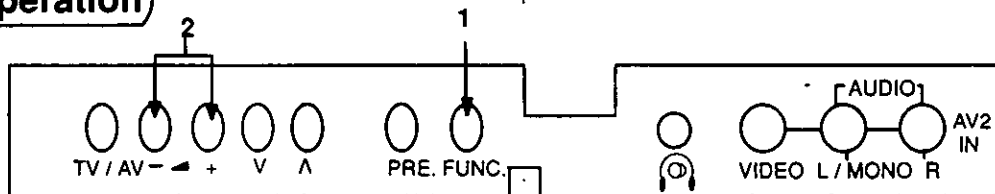

1.

Function Button



By pushing this button repeatedly, the Picture Control Function, Colour System, Sound System and Language Function will be displayed as follows.

2.

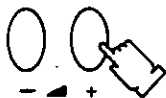

Push the Volume Up " + " or Down " - " Buttons to adjust the level and Select the Menu.

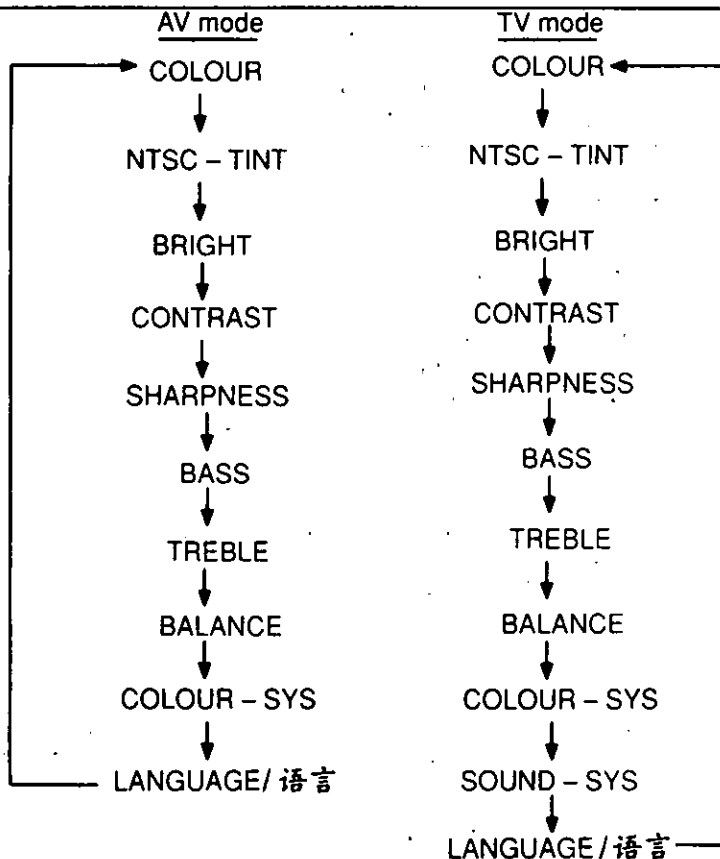

Note :

NTSC - TINT appear if NTSC 4.43 or NTSC 3.58 is selected.

General Operation

Colour System Selection

Use this function if a clear picture with weak colours is obtained when a Broadcast or AV signal is received.

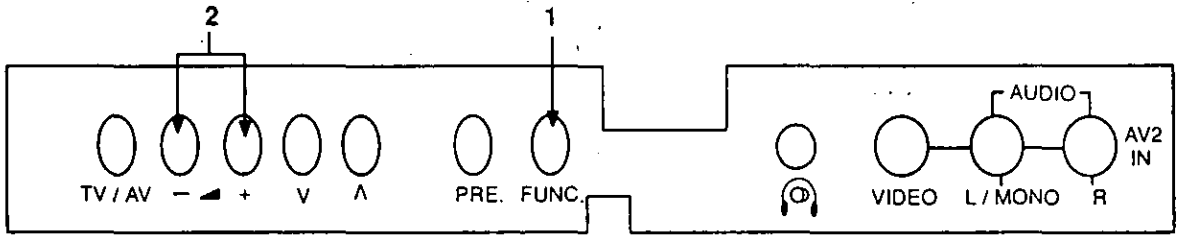

1.  By pressing the "FUNC." function button, you can select the Colour System Selection mode.

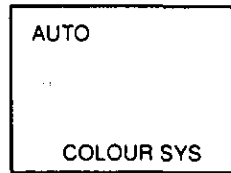

2.  Press the Volume "+" button repeatedly until the optimum image is produced.

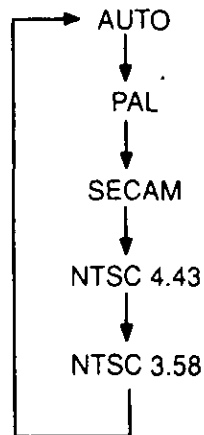

3. This returns the set to the normal viewing condition after 10 seconds.

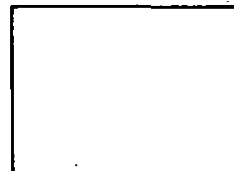

General Operation

Sound System Selection

This function is used only in the TV mode, and is not applicable in AV mode.
When the sound is not clear or no sound is produced on a programme number.

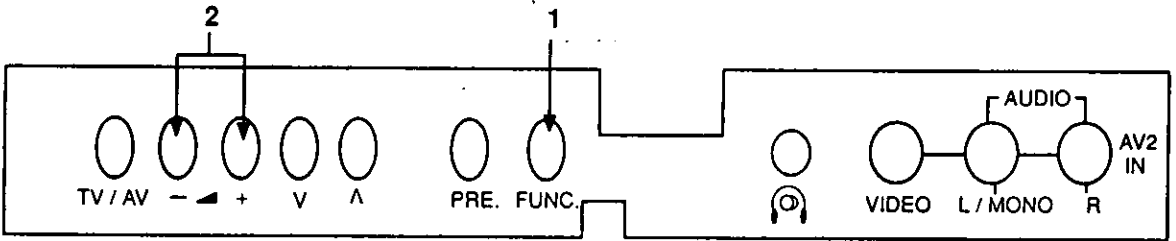

1.  By pressing the "FUNC." function button, you can select the Sound System Selection mode.

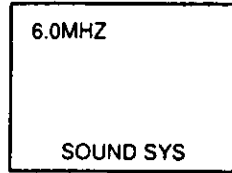

2.  Press the Volume "+" button repeatedly until the optimum sound is produced.

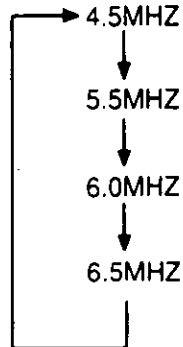

3. This returns the set to the normal viewing condition after 10 seconds.



Advanced Remote Control Operation

Surround Sound Operation

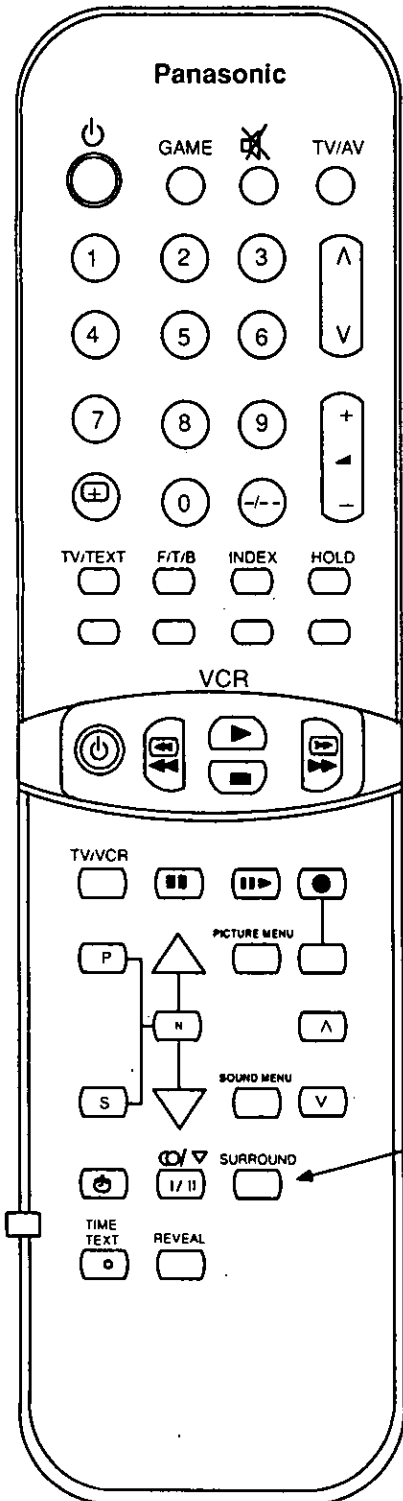

1. SURROUND



The benefit of surround sound are enormous. With additional speakers you can be completely enveloped in sound; just as if you were at a concert hall or cinema.

The surround effect does operate without external surround speakers, but is enhanced when they are connected. Such near surround speakers should not be sited in direct proximity to the listeners.

On-screen display during surround mode.

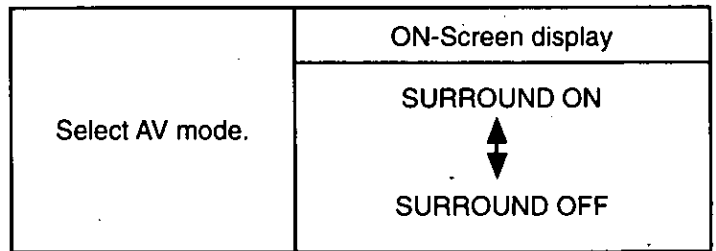

Advanced Remote Control Operation

Picture Menu Operation

1. PICTURE MENU



By pressing the PICTURE MENU button, you can sequentially select the Picture menus as shown below:

| On-screen | Function |
|-----------|-----------------------------------------------------------------------------------------------------------------|
| DYNAMIC | For watching in brighter environments. This menu selects a higher than normal level of brightness and contrast. |
| STANDARD | For watching in normal (evening) environments. This menu selects normal level of brightness and contrast. |
| SOFT | For watching in dark environments. This menu selects reduced level of brightness and contrast. |

2.



By pushing the Picture Control function button repeatedly, the on-screen display will be changed:

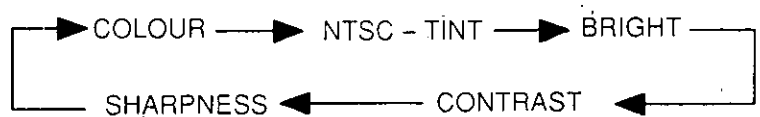

3.

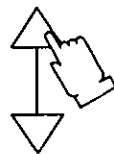

Push the level up or down buttons during display to adjust the level of the selected function.

Helpful Hint

1. You can change the level of each Function (COLOUR, NTSC-TINT, BRIGHT, CONTRAST, SHARPNESS) for each picture menu.
2. Picture menu mode will be memorized for each TV, AV1, AV2 and GAME mode.

Advanced Remote Control Operation

Sound Menu Operation

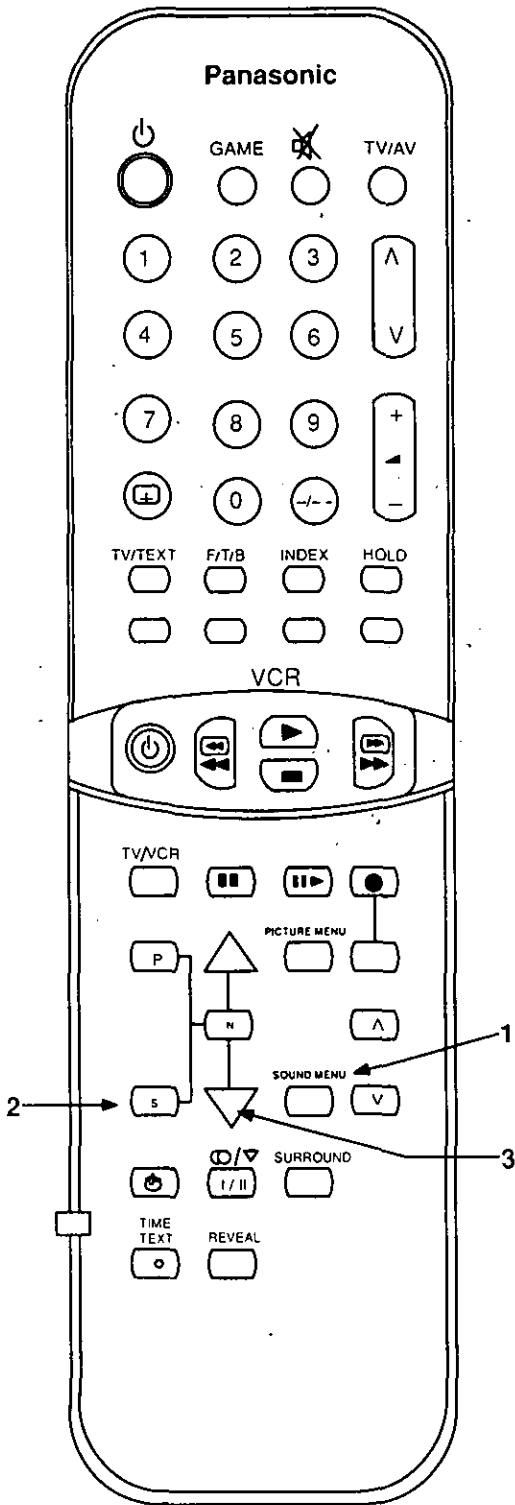

1. SOUND MENU



By pushing the SOUND MENU button, you can sequentially select the sound menus as shown below:

| On-screen | Function |
|-----------|----------------------------------|
| MUSIC | For music programme for example. |
| SPEECH | For News programme for example. |

2.



By pushing the SOUND CONTROL function button repeatedly, the on-screen display will be changed:

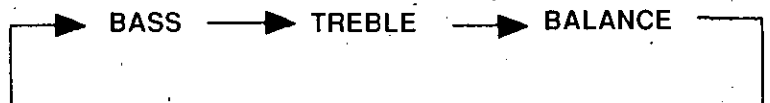

3.

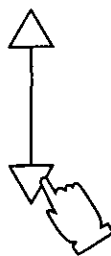

Push the level up or down buttons during display to adjust the level of the selected function.

Helpful Hint

1. You can change the level of each Function (BASS, TREBLE, BALANCE) for each sound menu.
2. Sound menu mode will be memorized for each TV, AV1, AV2 and GAME mode.

Advanced Remote Control Operation

Fastext

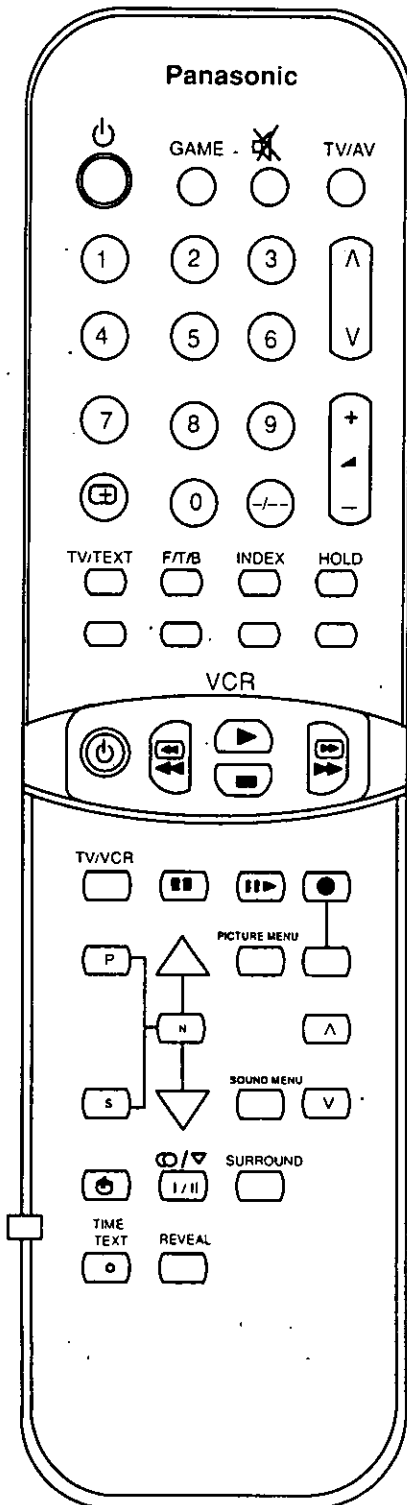

- Teletext features may vary depending on the Broadcasting companies and is only available if the channel selected is transmitting teletext.
- When in the teletext mode, the volume may still be altered to the desired listening level.

What is Fastext

In FASTEXT mode, four different coloured subjects are situated at the bottom of the display. To access more information about one of these subjects, push the appropriately coloured button. This facility enables fast access to information of the subjects shown.

What are the advantages

- Page selection at the touch of a Coloured-coded button.
- Easy to use step by step selected of the topical subject.
- Reduction of waiting time.
- Page status line at the bottom of screen so you always know which button will take you to the desired information.

Teletext Operation

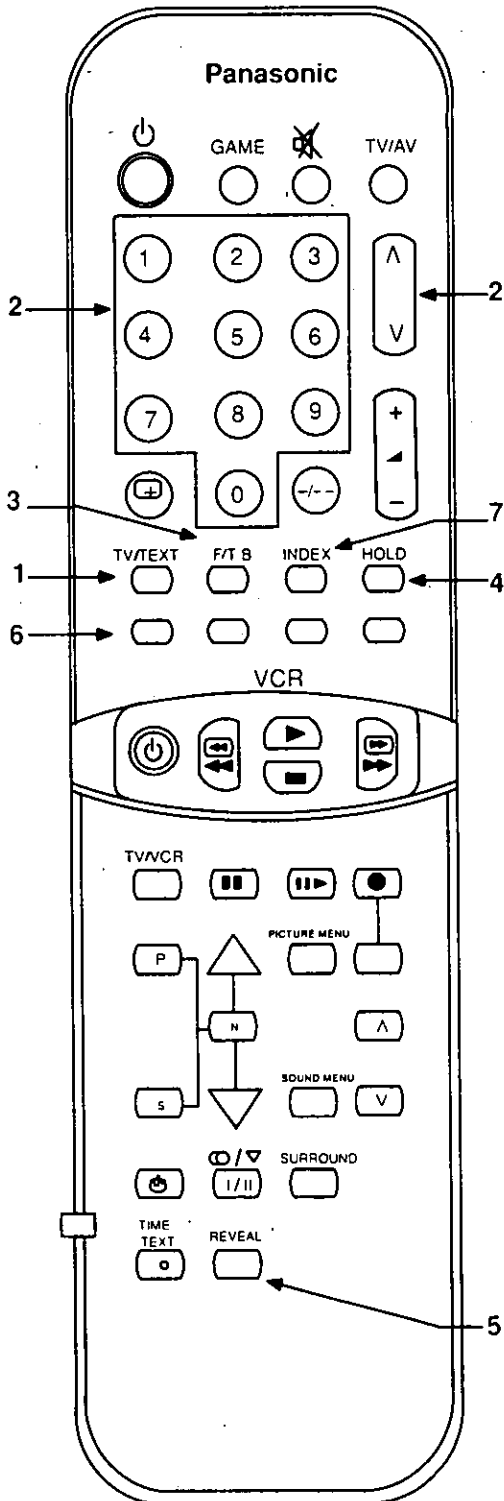

1. TV/TEXT



TV/Teletext mode

By pushing the TV/TEXT button, to change the TV/Teletext mode as follows:

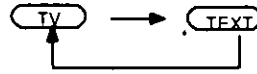

2.

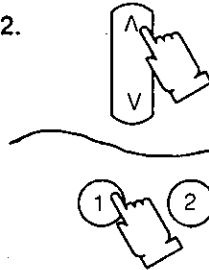

Page Selection

Pages can be selected in two ways:

- Push the Up / Down Buttons to increase or decrease the page number by one.
- By entering the page number, using 0 ~ 9 on the remote control.

3.



Full/Top/ Bottom

Push to expand the Top of the page. Push again to expand the Bottom half. Push again to return to normal (Full) size.

4.

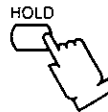

Hold

Push to hold the current page. Push again to cancel the hold.

5.



Reveal

Push to reveal hidden words. e.g. quiz page answer. Push again to hide.

6.

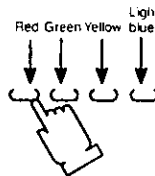

Colour-coded buttons

In Fastext mode these correspond to the differently coloured subjects.

7.



Index

Push INDEX to return to the main index page.

Sub Coded Page Access

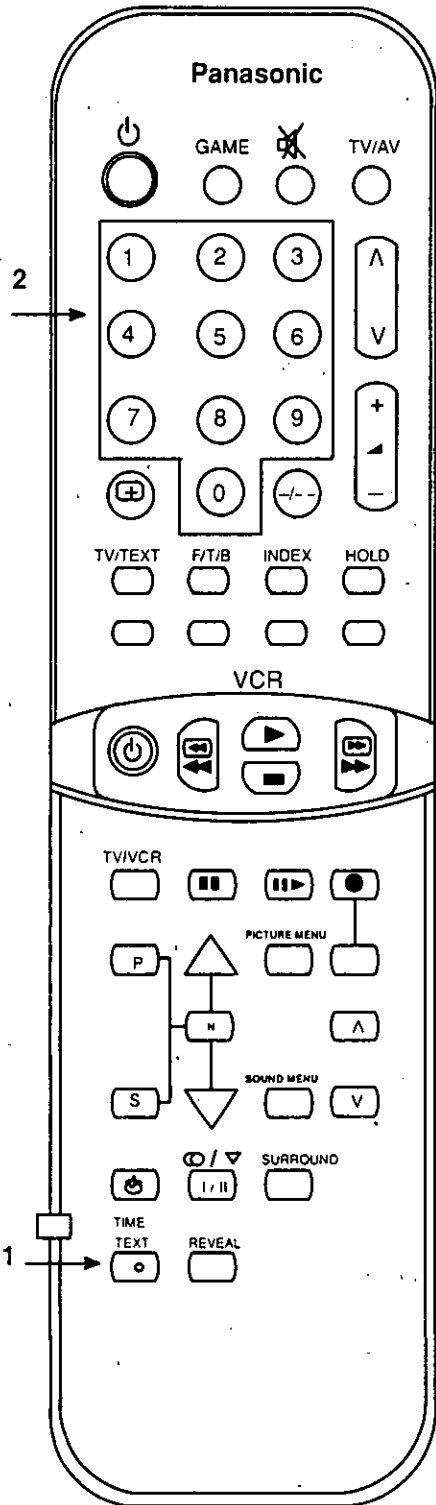

When teletext information exceeds more than one page, it may take sometime for the automatic changing of the sub pages to reach the sub page you require. It is possible to enter your required sub page until the correct sub page is found. Select the required page number using button 0-9.

1.



Press TIME TEXT "T****" will be displayed (top left of the screen).

2.

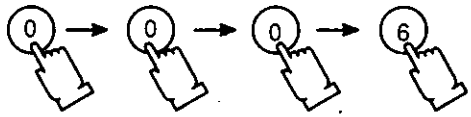

Enter desired sub page number before the "T****" disappears.

To select page 6 enter 0, 0, 0 and 6.

Operation of VCR

Your remote control is designed to be used with selected Panasonic/National VCRS.



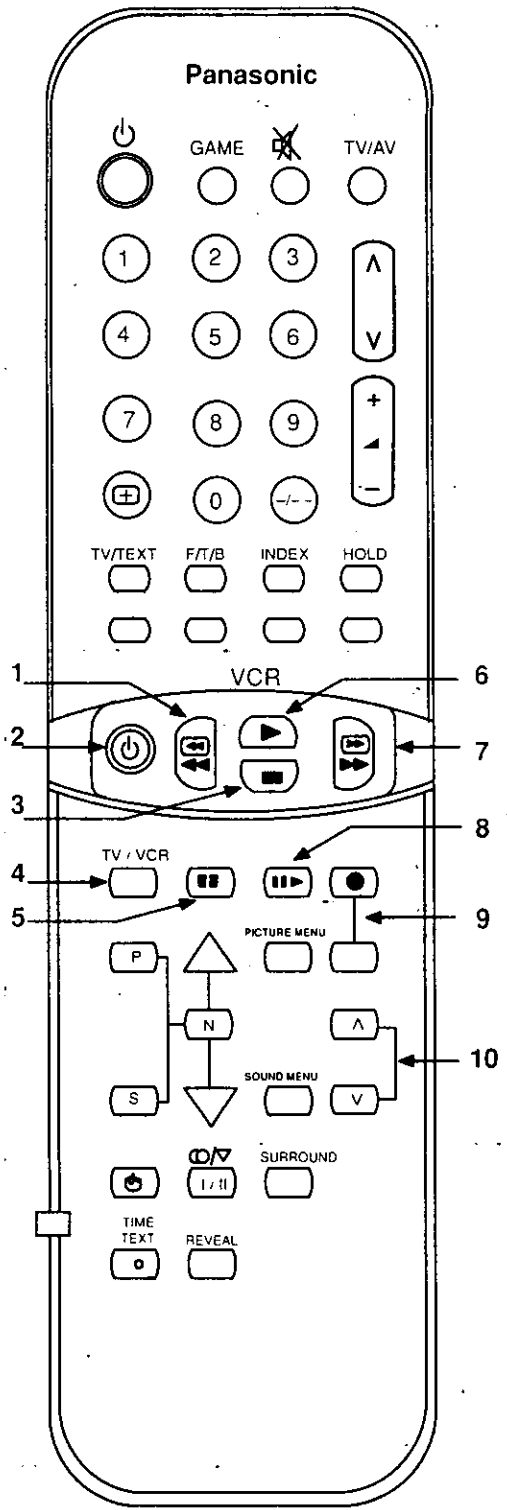

















Some VCR model have different functions, so please refer to the individual VCR instruction manual to ensure compatibility.



- 1. Rew (Rewind)/Review Button
- 2. VCR Power Button
- 3. Stop Button
- 4. TV / VCR Selection Button
- 5. Pause / Still Button
- 6. Play Button
- 7. FF(Fast forward)Cue Button
- 8. Still advance Button
- 9. Rec(Record) Button
- 10. Channel Up and Down Button for VCR

Troubleshooting

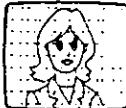
Before calling for service, determine the symptoms and make a few simple checks as shown below.

| Symptoms | | Checks |
|------------------------------------------------------------------------------------------------------------------------------------------------------------------------------------------------------------------------------------------------------------------------------------------------------------------|-----------------------------------------------------------------------------------------------------------------|-------------------------------------------------------------------------------------------------------------------------------------------------------------------------------------------------|
| Picture | Sound | |
|  <p>Snowy Picture</p> |  <p>Noisy Sound</p> | <p>Aerial Location, direction</p> <p>Connection</p> |
|  <p>Multiple Image</p> |  <p>Normal Sound</p> | <p>Aerial Location, direction</p> <p>Connection</p> |
|  <p>Interference</p> |  <p>Noisy Sound</p> | <p>Electrical Appliances</p> <p>Cars / Motorcycles</p> <p>Fluorescent Lamps</p> |
|  <p>Normal Picture</p> |  <p>No Sound</p> | <p>Volume</p> <p>(Check whether the mute function has been activated on the Remote Control.)</p> |
|  <p>No Picture</p> |  <p>No Sound</p> | <p>Not plugged into AC outlet</p> <p>Not switched on</p> <p>Contrast and Brightness / Volume Setting</p> <p>(Check by pushing the Power Switch or Stand-by Button on the Remote Control.)</p> |
|  <p>No Colour</p> |  <p>Normal Sound</p> | <p>Colour Control</p> |
|  <p>Scrambled</p> |  <p>Normal or Weak Sound</p> | <p>Re-tune Channels</p> |
|  <p>Colour Patches</p> |  <p>Normal Sound</p> | <p>Magnetic interference from unshielded equipment.</p> <p>Receiver moved while "ON".</p> |
|  <p>No Colour</p>  <p>Rolling Picture</p>  <p>H-Line</p> |  <p>Noisy Sound</p> | <p>System Button</p> |

Specifications

Power Source : AC AUTO 110/240V, 50/60 Hz

Power Consumption : 150 W

Receiving System : 17 SYSTEM

| | SYSTEMS | FUNCTION |
|---------------------------------------------|---------------------------------------------------------------------------------------------------------------------------------------------|---------------------------------------------------------------------------------------|
| 1. 2. 3. 4. 5. 6. 7. | PAL B,G,H PAL I PAL D,K SECAM B,G SECAM D. K. SECAM K1 NTSC M (NTSC 3.58 / 4.5MHZ) | Reception of broadcast transmissions and playback from video cassette tape recorders. |
| 8. 9. 10. 11. 12. 13. 14. | NTSC 4.43 / 5.5MHz NTSC 4.43 / 6.0MHz NTSC 4.43 / 6.5MHz NTSC 3.58 / 5.5MHz NTSC 3.58 / 6.0MHz NTSC 3.58 / 6.5MHz SECAM I | Playback from special VCR only. |
| 15. 16. 17. | PAL 60Hz / 5.5MHz PAL 60Hz / 6.0MHz PAL 60Hz / 6.5MHz | Playback from special Disc player and VCR only. |

Receiving Channels :

| VHF BAND | | UHF BAND | | CATV |
|----------|-----------------|----------|----------------------------|-----------------|
| 2 - 12 | PAL/SECAM B,K1 | 21 - 69 | PAL G,H,I / SECAM G, K, K1 | S1-S20 (OSCAR) |
| 0 - 12 | PAL B (AUS) | 28 - 69 | PAL B (AUS) | S21-S41 (HYPER) |
| 1 - 9 | PAL B (N.Z) | 13 - 57 | PAL D,K | 1-125 (USA) |
| 1 - 12 | PAL / SECAM D | 13 - 62 | NTSC M (JAPAN) | C13-C49 (JAPAN) |
| 1 - 12 | NTSC M (JAPAN) | 14 - 69 | NTSC M (U.S.A.) | 5A,9A (AUS) |
| 2 - 13 | NTSC M (U.S.A.) | | | Z1-Z37 (CHINA) |

Specifications

Tuning System : Voltage synthesizer
 .Auto search tuning 100 position

Picture Tube : 59 cm, measured diagonally, 110° deflection

Audio Output : 2 X 5 W

Aerial Impedance : 75 Ω Unbalanced coaxial

Video/audio terminal :

| | | | | | |
|-----|------------|------------------|-------------|-----------|---------------|
| AV1 | S-Video in | Y: 1.0 Vp-p, 75Ω | AV2 | Video in | 1 Vp-p, 75Ω |
| | | C: 0.3 Vp-p, 75Ω | | Audio in | Approx: 400mV |
| | Video in | 1 Vp-p, 75Ω | Monitor out | Video out | 1 Vp-p, 75Ω |
| | Audio in | Approx: 400mV | | Audio out | Approx: 400mV |

Remote Control Transmitter : EUR 51973

Battery : R6 (AA) X 2 .

Dimension (W x D x H) : 735.5 x 447.6 x 532.5 mm

Weight (Net): 28Kg

Note :

Design and Specifications are subject to change without notice.



Customer's Record :

The serial number of this product can be found on its rear cover. You should note this serial number in the space provided below and retain this book plus your purchase receipt as a permanent record of your purchase to aid in identification in the event of theft or loss, and for warranty Service purposes.

Model Number : _____

Serial Number : _____

Matsushita Electric Industrial Co., Ltd

Central P.O. Box 288, Osaka 530-91, Japan.